

# SALTO Neo Modular Cylinder Kit

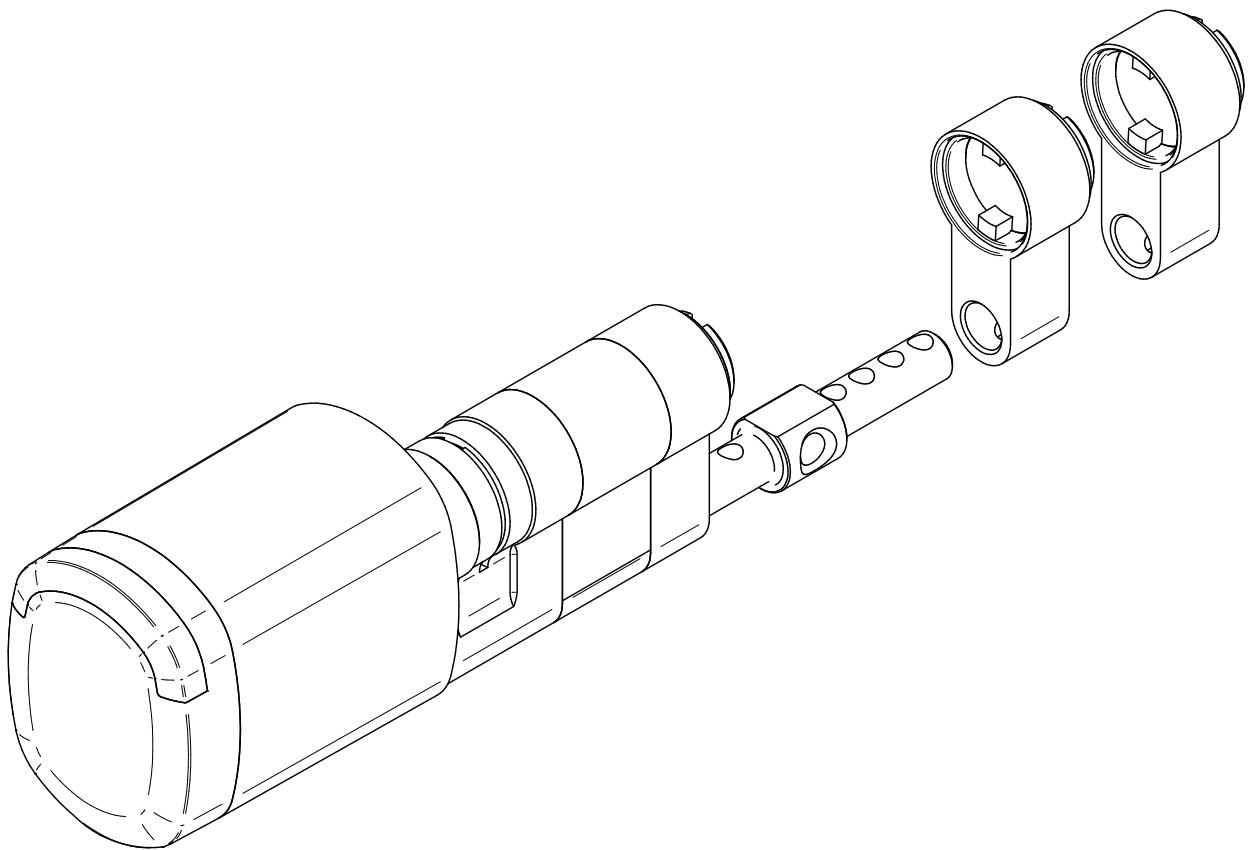

SKG\*\*\* Only in combination with NiOE...G cylinders.

## THIS KIT CONTAINS:

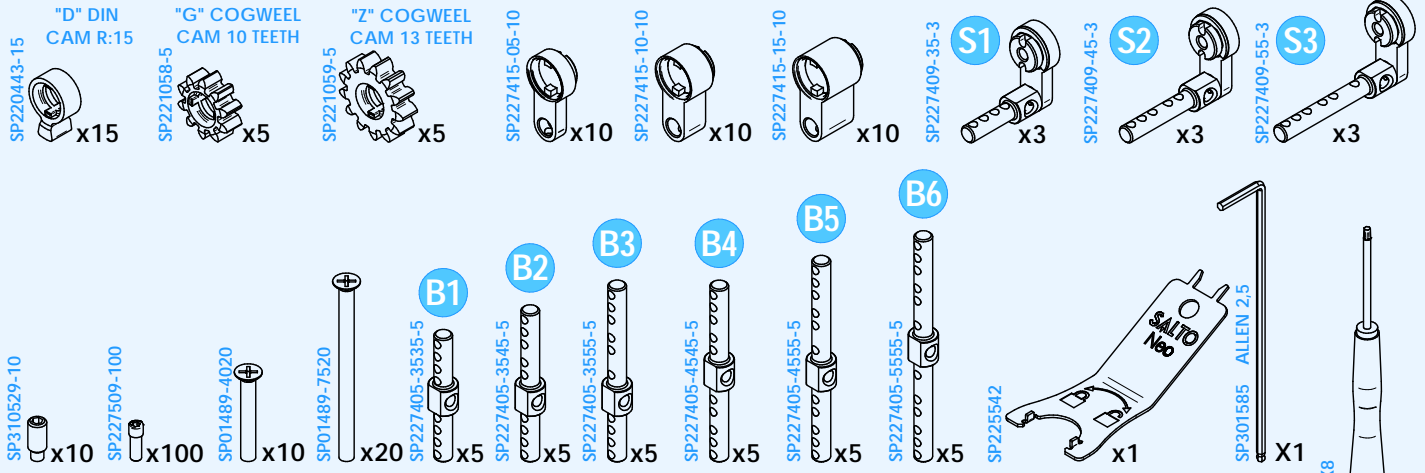

## SPKNEOM1

## HOW TO ORDER THE CYLINDER

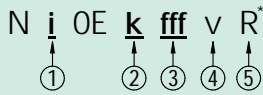

### 1 ID TECHNOLOGY (i)

J	HID iCLASS+ Bluetooth LE
M	MIFARE + BLUETOOTH LE + HSE

### 2 KNOB TYPE (k)

1	STANDARD
2	PLUG + 5mm
3	PLUG + 10mm

### 3 FINISH (fff)

	DENOMINATION	READER
CSB	SATIN CHROMIUM	Black
CSW	SATIN CHROMIUM	White
CPB	POLISHED CHROMIUM	Black
CPW	POLISHED CHROMIUM	White
PPB	BRIGHT BRASS TYPE (PVD)	Black
PPW	BRIGHT BRASS TYPE (PVD)	White
PMB	SATIN BRASS TYPE (PVD)	Black
PMW	SATIN BRASS TYPE (PVD)	White
NEB	SATIN CHROMIUM BLACK	Black
BCB	BIOCOTE (SATIN CHROMIUM)	Black

### 4 CERTIFICATES (v)

	SALTO STANDARD	
G	SKG***	(1)

### 5 WATER RESISTANCE (R)

R	OUTDOOR VERSION
---	-----------------

(1) By default, outdoor version.

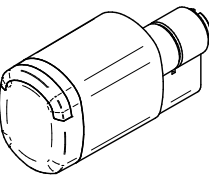

Cylinder not included on the SALTO Neo Modular Cylinder Kit briefcase!  
For cylinder and other Spare Parts, order separately!

Knob Security Screw  
**CLICK HERE**

Other Knobs  
**CLICK HERE**

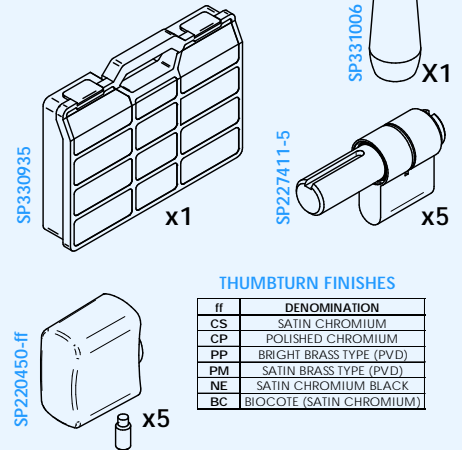

## Compatibility

### "E1" EUROPEAN HALF PROFILE CYLINDERS

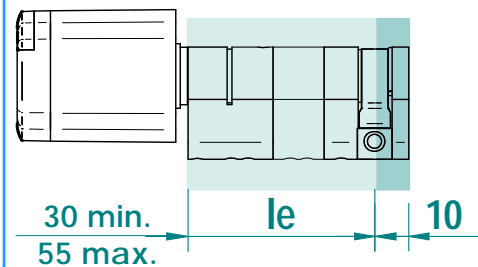

### "E2" EUROPEAN PROFILE WITH THUMBTURN CYLINDERS

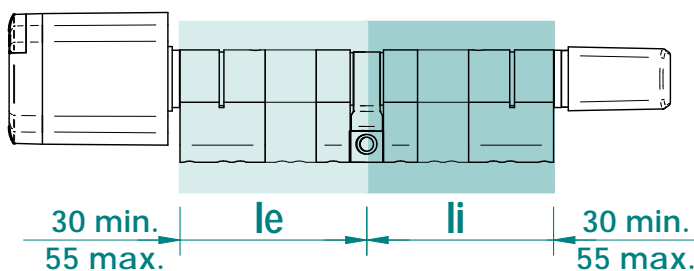

### "E3" EUROPEAN PROFILE DOUBLE READER CYLINDERS

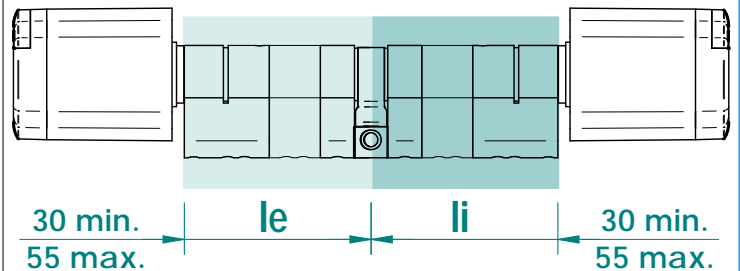

## "E1" EUROPEAN PROFILE HALF CYLINDERS

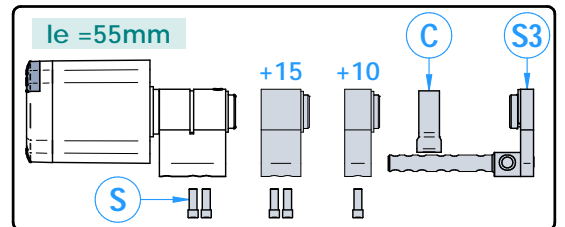
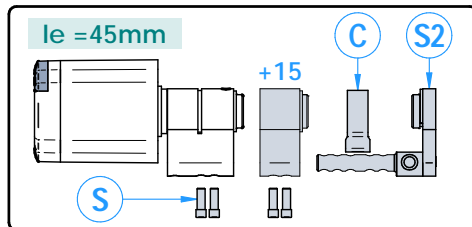
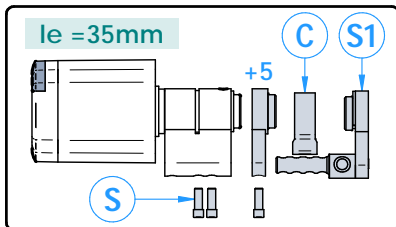
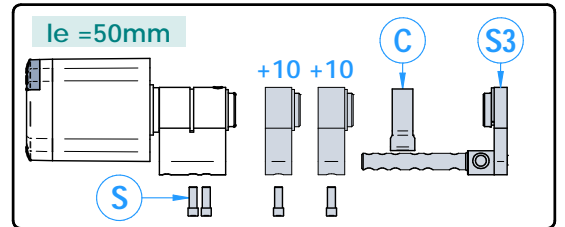
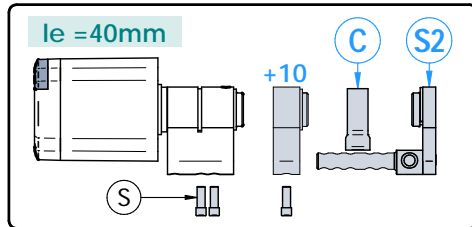
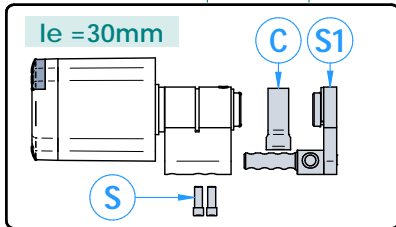
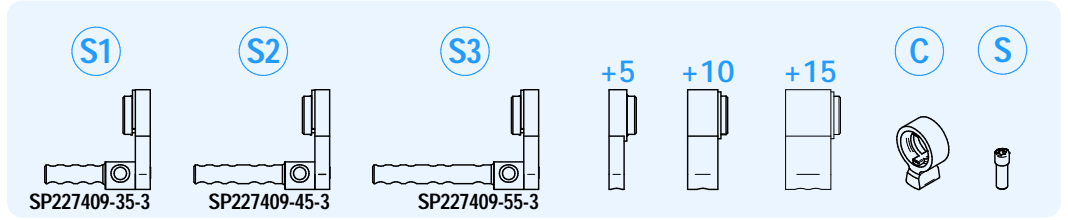
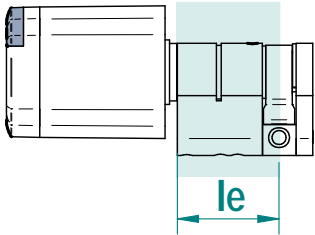

## "E2" EUROPEAN PROFILE WITH THUMBTURN CYLINDERS

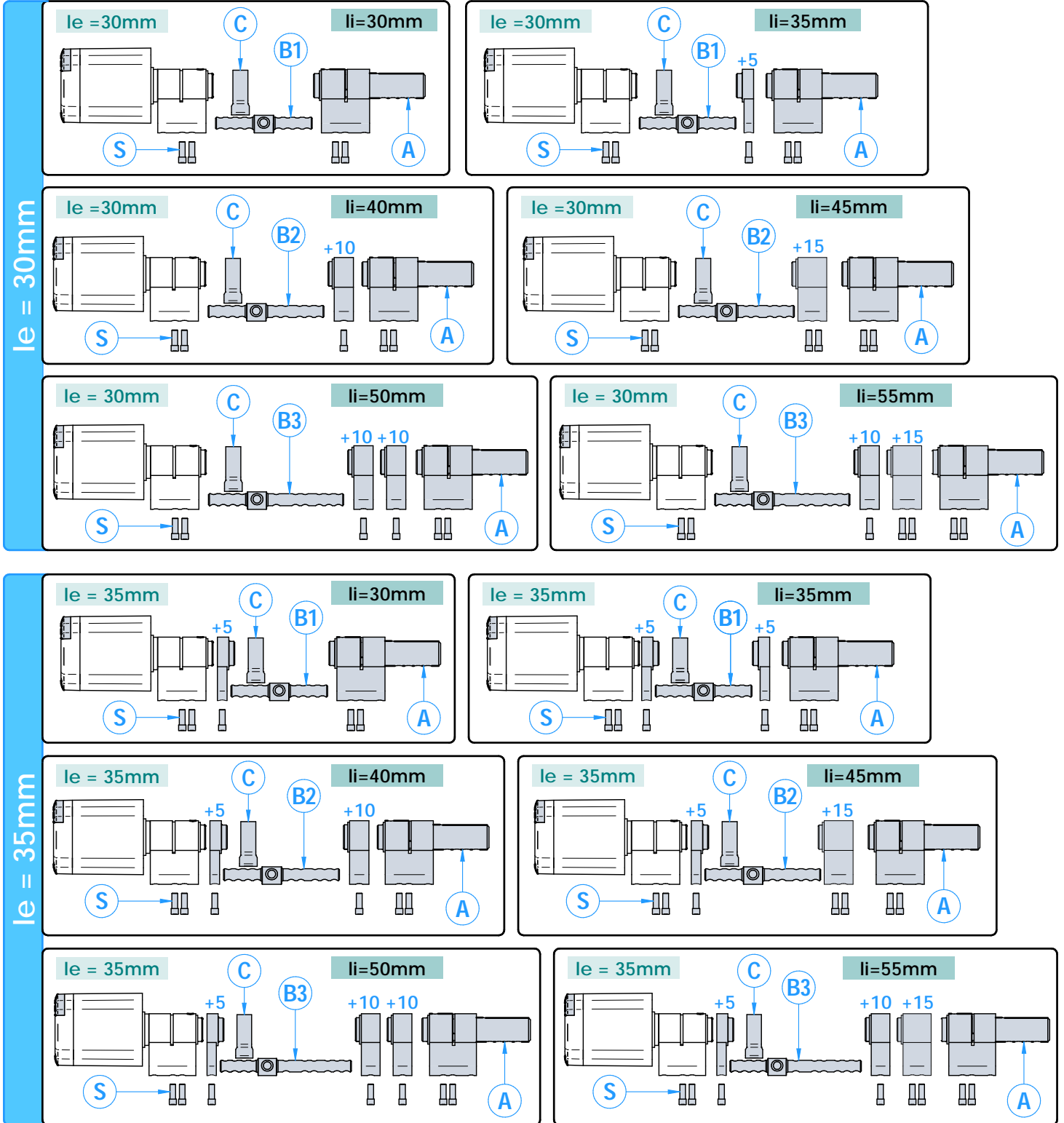
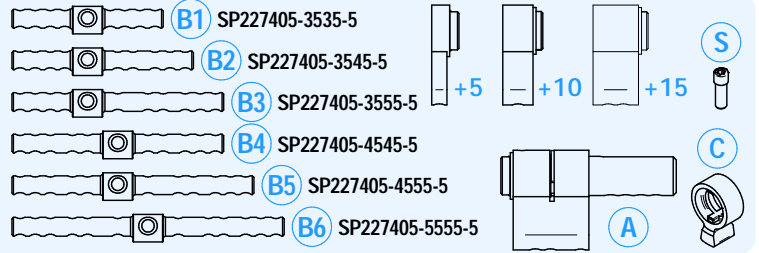
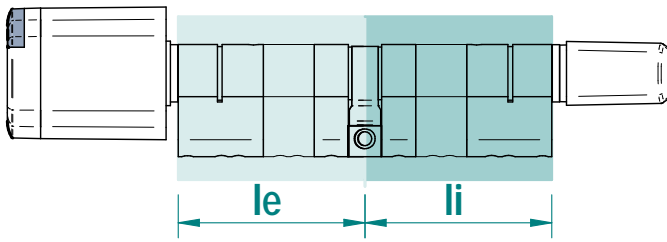

## "E2" EUROPEAN PROFILE WITH THUMBTURN CYLINDERS

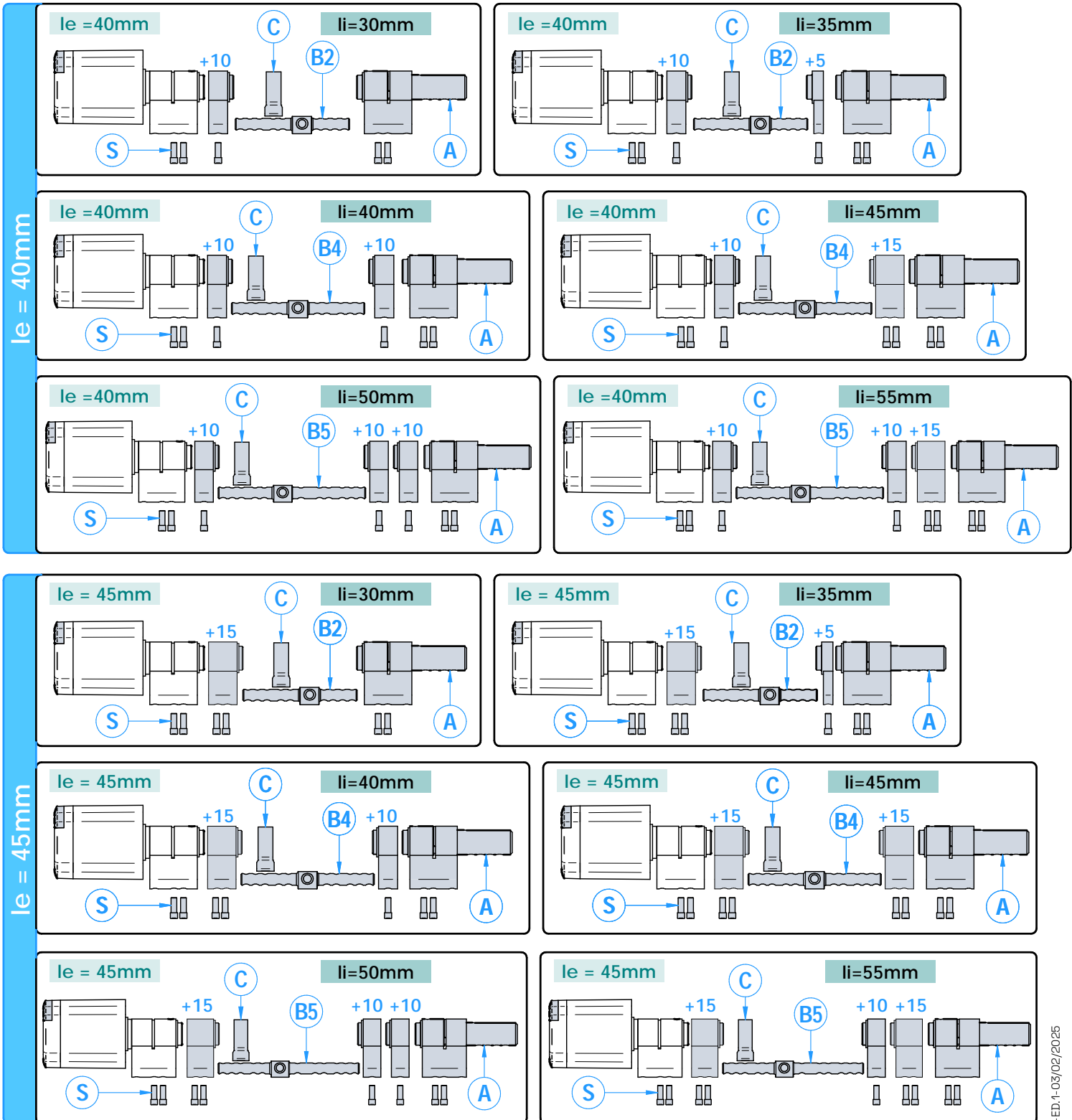
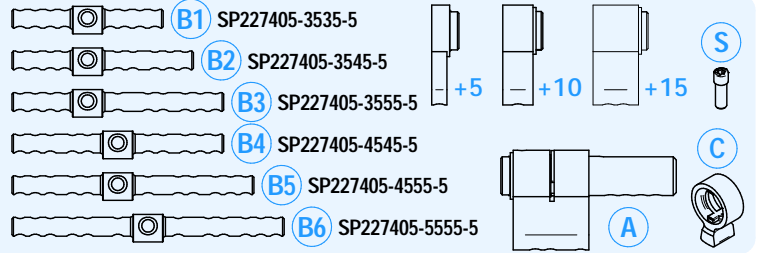
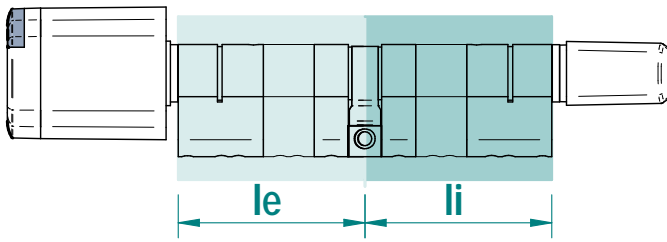

## "E2" EUROPEAN PROFILE WITH THUMBTURN CYLINDERS

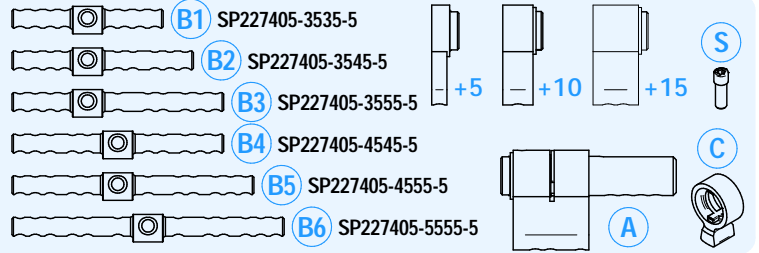
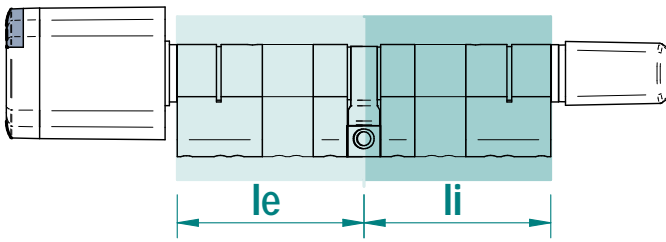

<b>le = 50mm</b>	<p><b>le = 50mm</b>      <b>li = 30mm</b></p>	<p><b>le = 50mm</b>      <b>li = 35mm</b></p>	
	<p><b>le = 50mm</b>      <b>li = 40mm</b></p>	<p><b>le = 50mm</b>      <b>li = 45mm</b></p>	
	<p><b>le = 50mm</b>      <b>li = 50mm</b></p>	<p><b>le = 50mm</b>      <b>li = 55mm</b></p>	
	<b>le = 55mm</b>	<p><b>le = 55mm</b>      <b>li = 30mm</b></p>	<p><b>le = 55mm</b>      <b>li = 35mm</b></p>
		<p><b>le = 55mm</b>      <b>li = 40mm</b></p>	<p><b>le = 55mm</b>      <b>li = 45mm</b></p>
		<p><b>le = 55mm</b>      <b>li = 50mm</b></p>	<p><b>le = 55mm</b>      <b>li = 55mm</b></p>

## "E3" EUROPEAN PROFILE DOUBLE READER CYLINDERS

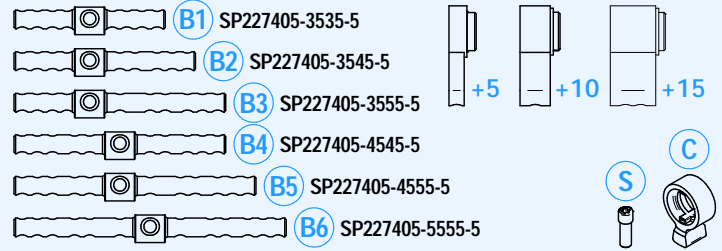
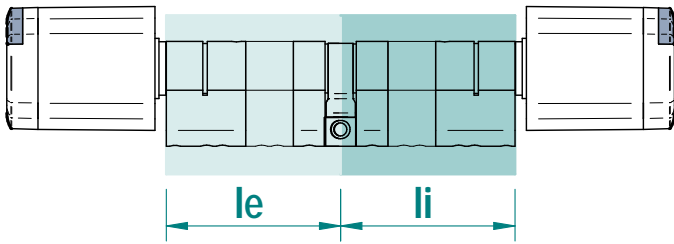

le = 30mm	<p>le = 30mm      li = 30mm</p>	<p>le = 30mm      li = 35mm</p>	
	<p>le = 30mm      li = 40mm</p>	<p>le = 30mm      li = 45mm</p>	
	<p>le = 30mm      li = 50mm</p>	<p>le = 30mm      li = 55mm</p>	
	le = 35mm	<p>le = 35mm      li = 30mm</p>	<p>le = 35mm      li = 35mm</p>
		<p>le = 35mm      li = 40mm</p>	<p>le = 35mm      li = 45mm</p>
		<p>le = 35mm      li = 50mm</p>	<p>le = 35mm      li = 55mm</p>

## "E3" EUROPEAN PROFILE DOUBLE READER CYLINDERS

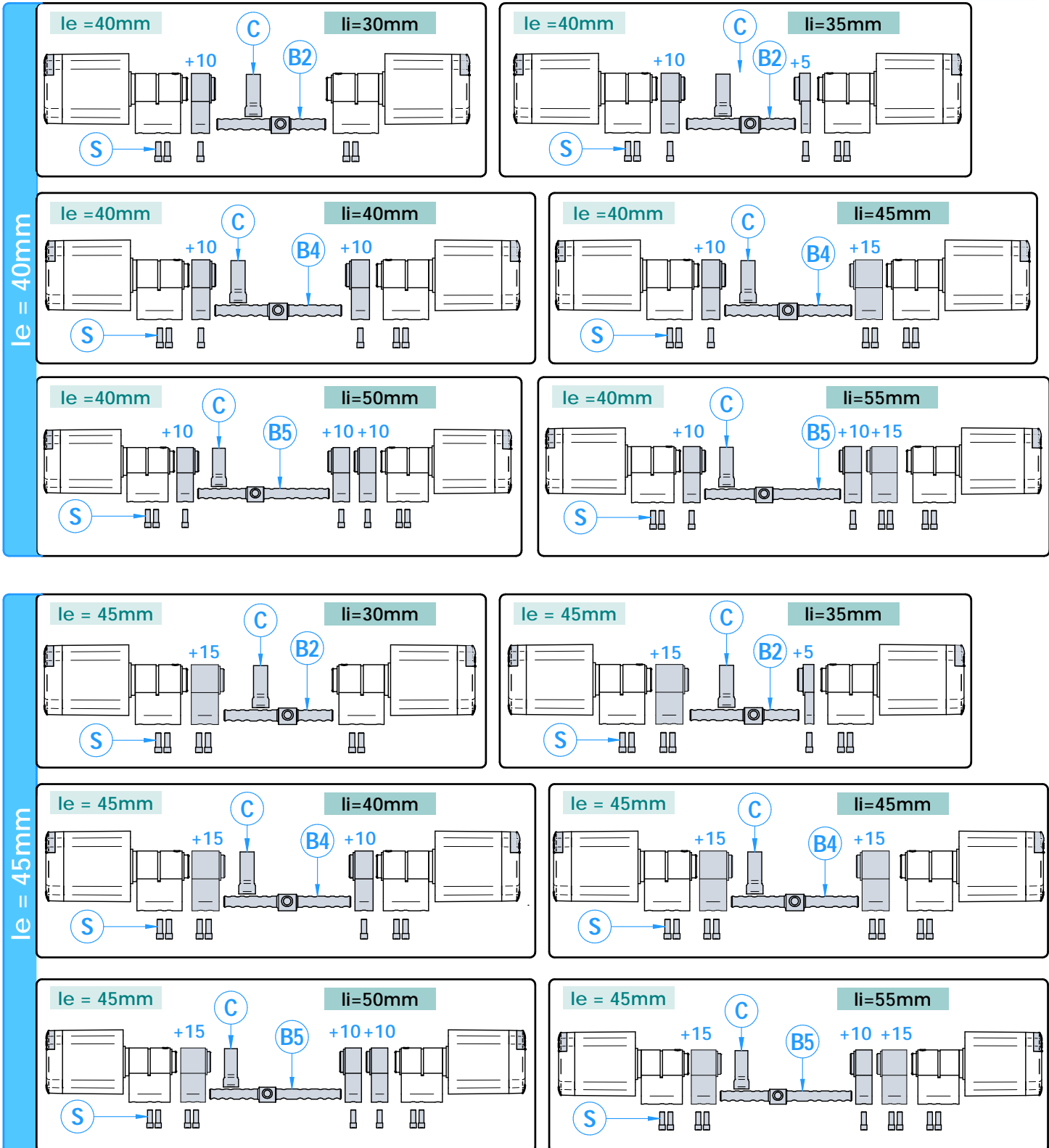
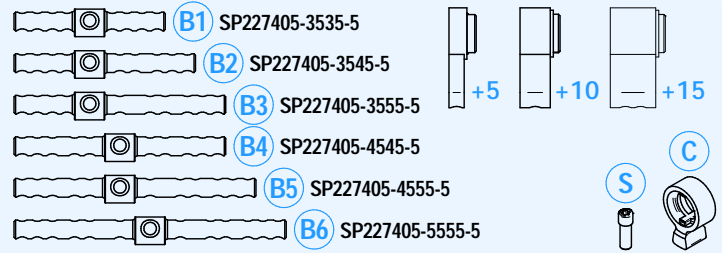
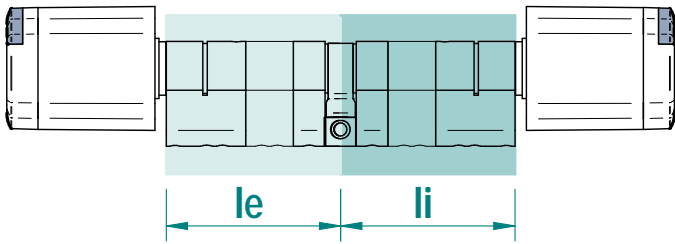



## "E3" EUROPEAN PROFILE DOUBLE READER CYLINDERS

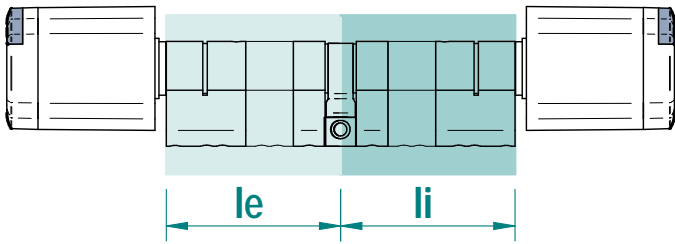

	<b>B1</b> SP227405-3535-5	
	<b>B2</b> SP227405-3545-5	
	<b>B3</b> SP227405-3555-5	
	<b>B4</b> SP227405-4545-5	
	<b>B5</b> SP227405-4555-5	
	<b>B6</b> SP227405-5555-5	

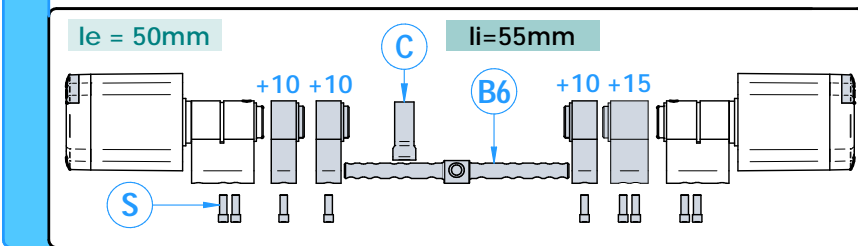
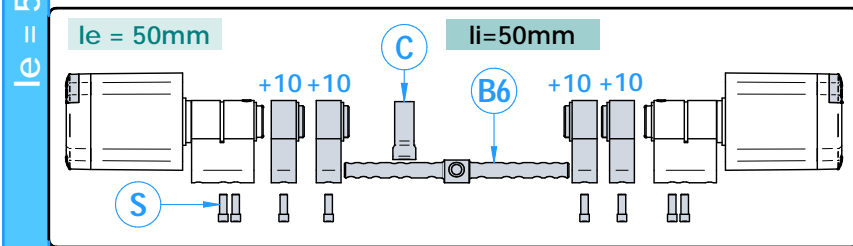
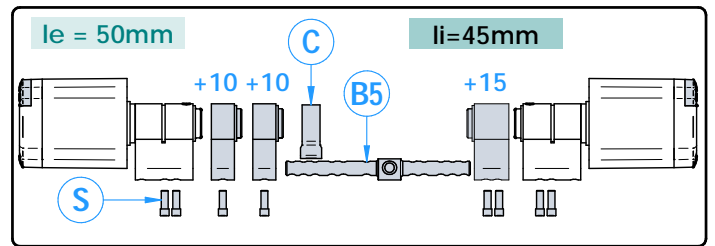
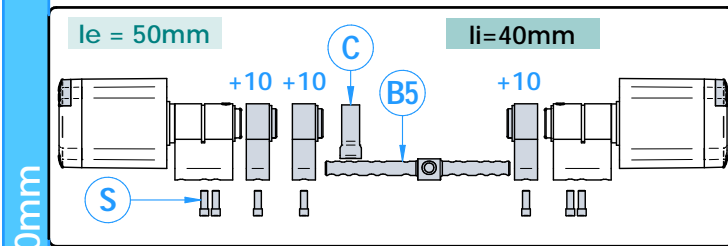
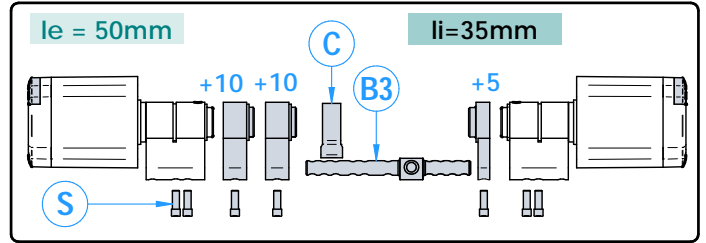
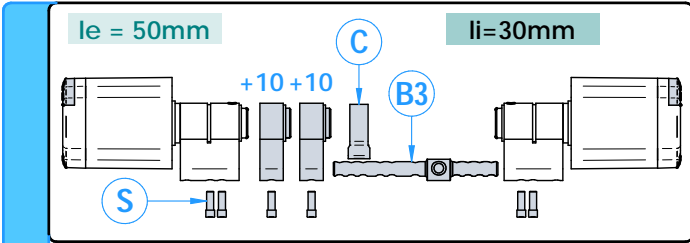

$le = 50\text{mm}$

## "E3" EUROPEAN PROFILE DOUBLE READER CYLINDERS

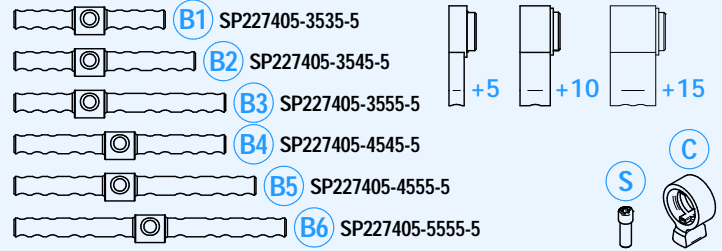
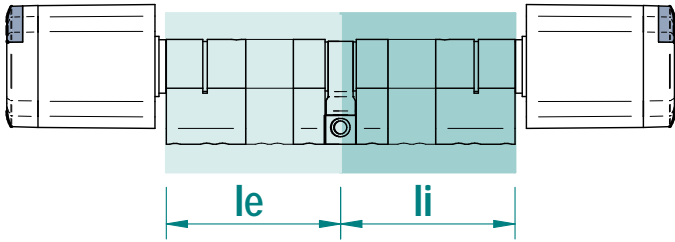

le = 55mm

